

Model Number: 3-PT15

Serial Number: _____

THE HURRICANE

3-PT 15 DITCHER



HURRICANE DITCHER CO., INC.

2425 Cathlinette Rd.
Vincennes, IN 47591

812-886-9663 Fax 812-886-0530



www.hurricane-ditcher.com

e-mail: info@hurricane-ditcher.com



TABLE OF CONTENTS

INTRODUCTION..... 3
SPECIFICATIONS OF THE MODEL 3-PT 15 3
SAFETY PRECAUTIONS 4-5
WARNING LABELS & ILLUSTRATION..... 5
TRANSPORTATION 6
UNHITCHING FROM TRACTOR..... 6
USING THE MODEL 3-PT 15..... 6-7
CHECKLIST BEFORE OPERATION..... 7
OPERATING INSTRUCTIONS 7-8
MAINTENANCE 8-9
LUBRICATION 9
FREE MOVEMENT OF DRIVELINE..... 9-10
IDLER ADJUSTMENT 10
LIMITED WARRANTY 11
PARTS LIST..... 12
PARTS ILLUSTRATION 13
OPTIONS PARTS LIST & ILLUSTRATION 14
MAINTENANCE LOG 15-16
NOTES..... 17

	CAUTION!!!!	
<ul style="list-style-type: none">• Read the Operator’s Manual.• Learn to operate this machine SAFELY.• Be alert. Observe ALL Safety Practices.• Machines can be hazardous in the hands of an UNFAMILIAR, UNTRAINED or COMPLACENT operator.• Do not risk INJURY or DEATH!		

INTRODUCTION

Thank you and congratulations on the purchase of your Hurricane Ditcher Model 3-PT 15. We certainly hope that it will be helpful and useful to you. As with all of our ditchers, it has been tested and built with knowledge, precision, and quality for years of dependable service. As a leader in the ditching industry since 1984, we continually build on our experience and use customer feedback to maintain and improve the quality and dependability of our machines.

In order to fulfill a need in agriculture, the 3-PT 15 was developed in 1992 as an efficient and affordable machine used to make surface drainage ditches using a standard farm tractor. It is also being utilized by farmers for building or reshaping terraces, as well as, by county highway departments for cleaning roadside ditches. Whatever your application, we hope it works well for you.

Please read and follow all safety precautions, operating procedures and maintenance requirements. Following these recommendations will prevent injury and operation down time. Proper maintenance and lubrication will prevent machine breakdown and increase its life expectancy, which will lead to better performance for you.

Please let us know of any comments, suggestions, or problems that may arise.

HURRICANE DITCHER CO., INC.
 2425 Cathlinette Road
 Vincennes, IN 47591
 812-886-9663
www.hurricane-ditcher.com
info@hurricane-ditcher.com

YOUR AUTHORIZED HURRICANE DITCHER DEALER:



SPECIFICATIONS OF THE MODEL 3-PT 15

- HP required: 50 to 140 HP on 540 or 1000 RPM PTO
- Width of cut: 15 inches with standard 5 paddle impeller wheel; 21 inches with optional 6 paddle impeller wheel
- Depth of cut: up to 10 inches in a single pass; up to 16 inches in multiple passes with standard 5 paddle impeller wheel; up to 20 inches in multiple passes with optional 6 paddle impeller wheel
- Volume of soil moved: with 70 HP tractor, up to 147 cubic yards per hour (2.45 cubic yards per minute); with 140 HP tractor, up to 427 cubic yards per hour (7.1 cubic yards per minute)
- Weight of machine: approximately 800 pounds without optional components; approximately 1,050 pounds with optional components
- Drive train: 55 series PTO with shear bolts which overload at the tractor end; double 80 roller chain with idler adjustment
- Certain brands of tractors could require different length PTO and/or hydraulic hoses. Contact your dealer for detailed specifications.

SAFETY PRECAUTIONS



OBSERVE THIS SYMBOL THROUGHOUT THIS MANUAL. It calls out potential hazards and dangers. This symbol will be associated with a key SIGNAL WORD that will designate a degree or level of hazard seriousness. These signal words are as follows:

DANGER! Indicates an imminently hazardous situation that, if not avoided, **WILL** result in death or serious injury; a danger that safety guards cannot protect against.

WARNING! Indicates a potentially hazardous situation that, if not avoided, **COULD** result in death or serious injury, and includes hazards that are exposed when guards are removed; also an alert to unsafe practices.

CAUTION! Indicates a potentially hazardous situation that, if not avoided, **MAY** result in minor or moderate injury; also an alert to unsafe practices.

BEFORE OPERATION:

- Carefully study and understand this manual. Be sure the operator has read and understands all operations before using this machine.
- Do not wear loose-fitting clothing which may catch in moving parts.
- Learn to operate this machine safely. Be alert and observe all safety practices. Machines can be hazardous in the hands of an unfamiliar, untrained or complacent operator. Never risk injury or death!
- After servicing, be sure all tools and servicing equipment have been removed from the machine.
- Be certain there is no one near the machine before starting.
- Do not stand under or near deflector shield.
- Do not use the ditcher until you are **certain** that the area in which you are preparing to work is clear. Be especially watchful for people, animals and moving vehicles that may enter the discharge path. Remember, soil may be thrown over 50 feet, rocks and other debris may go farther, so use extreme caution in any area with buildings or objects that could be damaged from flying debris.



- **WARNING!** Do not operate this machine above 540 RPM if ditcher is rated for 540 RPM; above 1000 RPM if ditcher is rated for 1000 RPM. Excessive speed of PTO can be dangerous and could cause personal injury or damage to your tractor or ditcher.



- **WARNING!** Do not exceed recommended horsepower (140 HP or less) for this machine. Excessive horsepower can be dangerous.



- **CAUTION!** Make sure drawbar is moved to one side. Do not leave drawbar in middle of your tractor as PTO damage may occur!
- Before each use, inspect the lower shaft behind the impeller wheel for material wrapped around shaft. Failure to keep shaft clear could result in bearing failure and is not covered under warranty.

DURING OPERATION:

- Keep all shields in place.
- Allow no one to stand on the left side (discharge side) of the machine while it is in operation, whether it is moving or standing still.

- **NO PASSENGERS ALLOWED!** Do not allow anyone to ride on ditcher at any time.
- Keep clear of all moving parts.
- Disengage the PTO and shut off tractor engine before servicing, cleaning or clearing a clogged machine.
- Avoid overhead wires; contact could cause serious injury or death.

WARNING LABELS & ILLUSTRATION

<u>ITEM</u>	<u>PART #</u>	<u>DESCRIPTION</u>
A1	009040	WARNING – KEEP ALL SHIELDS IN PLACE
B1	009030	WARNING – DO NOT EXCEED 1000 RPM ON PTO
C1	009010	DANGER – STAY CLEAR OF MACHINE WHEN IN OPERATION
D1	009020	DANGER – ROTATING DRIVE LINE

Note: Manufacturer will replace decals upon request when worn, damaged or missing.

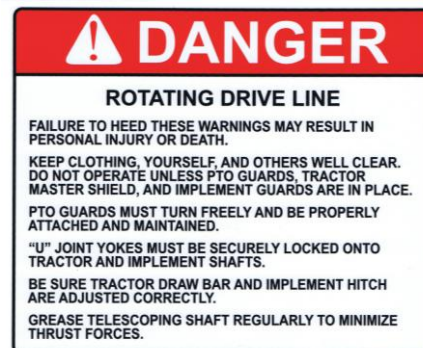
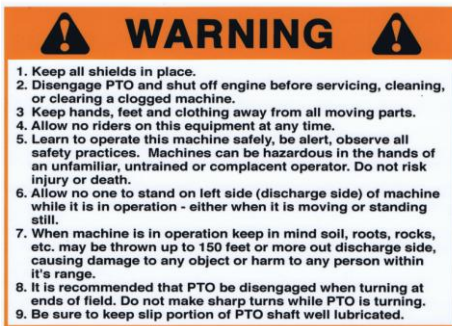

TRANSPORTATION

If you will be transporting your ditcher on a trailer or in the back of your pickup truck, make sure the machine is safely secured. It may cause injury to yourself or others, or damage the machine if it is not securely tied down. You may wish to place boards under each parking stand and the drag plate to prevent damage to the floor of your pickup or trailer.

UNHITCHING FROM TRACTOR

- 1) Park on level ground far enough from obstacles that the deflector shield may be lowered. See Note below.
- 2) Lower parking stands; insert parking stand lock pins to secure.
- 3) Lower ditcher until it is sitting firmly on parking stands and drag plate.



WARNING! Always shut tractor engine off before unhooking PTO.

- 4) Pull the PTO safety slide lock (*See page 13 item L5*) back on the PTO and remove from tractor spline.
- 5) Place PTO in its holder.
- 6) If using a quick hitch, release the quick hitch latches, lower the quick hitch, and slowly pull forward.
- 7) If not using a quick hitch, remove the lynch pins, hitch pins, and spacers, and slowly pull forward.
- 8) Return lynch pins, hitch pins, and spacers to ditcher hitch.

Note: If your ditcher is equipped with the optional deflector shield, lower it, release the hydraulic pressure from the lines and disconnect the quick couplers from the tractor before pulling forward. Always clean the quick couplers before reconnecting them to any hydraulic system. If unhitching your ditcher with the deflector shield attached, additional support may be required to keep the ditcher from tipping over. Do not risk personal injury or damage to machine from insufficient support.

USING THE MODEL 3-PT 15

Each customer will use their machine for different purposes and in slightly different ways. We cannot tell you the proper way to use your machine for your particular purpose, but we can make recommendations for various uses.

BUILDING OR REWORKING A DRAINAGE DITCH – The ditcher throws soil and debris to the left side. When possible, it is more efficient if the soil is thrown to both sides of the ditch or waterway. To do this, make your first pass in the center of your ditch or waterway. After turning around, make your second pass in the opposite direction with the right wheel of your tractor in the cut you just made. Operate the machine's impeller wheel 5-6 inches deep and travel about 2½ miles per hour. If the ditch or waterway needs to be deeper, start in the center again and work outward. If the ditch needs to be deeper but the soil is unable to be thrown out due to the steepness of the ditch bank, take an additional pass cutting soil off the left bank. This will allow you to make an additional pass traveling in the same direction cutting soil in the bottom of the ditch and make it easier to discharge the soil. Even if you have excess horsepower, it is best not to cut over 6 inches deep. Running 5-6 inches deep per pass allows a natural slope to the center of the area you are working. This same process is used when cleaning a terrace channel.

RESHAPING OR BUILDING A TERRACE – The deflector shield would be lowered to build up your terrace when traveling in one direction and raised scattering the soil back up the hill when traveling the other way. This procedure allows you to increase the water capacity of your terrace without a high terrace ridge and also allows your good topsoil to be distributed back into the area where it is needed.

This machine can be used to clean small roadside ditches, as well. (Remember, the soil is thrown out the left side of the machine and may be distributed over a 50 foot area; rocks and other debris may go farther.) The maximum depth of cut for the 3-PT 15 is approximately 16 inches depending on how your tractor is set up (primarily tire size).

CHECKLIST BEFORE OPERATION

- Read and understand the operator's manual.
- Read all information on the safety decals on the machine.
- Check all bolts to make sure they are tight.
- Before connecting to tractor PTO and as general daily maintenance, check for free movement of driveline and/or slack in chain (*See Free Movement of Driveline section on page 9-10*).



- **WARNING!** Do not operate this machine above 540 RPM if ditcher is rated for 540 RPM; above 1000 RPM if ditcher is rated for 1000 RPM. Excessive speed of PTO can be dangerous and could cause personal injury or damage to your tractor or ditcher.
- Check that all hydraulic hoses are secured and will not interfere with the tractor wheels, PTO shaft or any other part.
- Be sure the PTO is hooked up correctly and will not interfere with the drawbar on the tractor.
- Be sure the hitch is secure.
- Check your tractor's hydraulic oil reservoir level (*See Lubrication section on page 9*).
- Lubricate machine (*See Lubrication section on page 9*).
- Check PTO forward travel. PTO must slide freely and must not bottom out, otherwise damage to bearings and shaft may occur.
- Before running machine each season or once per year, remove the shear bolts and lock nuts from the PTO shear yoke assembly to verify that the shear yoke is not corroded and will move freely. Reinstall shear bolts and lock nuts after inspection is complete.

OPERATING INSTRUCTIONS

- 1) Keep all shields in place.
- 2) Keep hands, feet and clothing away from all moving parts.
- 3) Do not allow anyone to ride on this equipment at any time.
- 4) Learn to operate this machine safely. Be alert and observe all safety practices. Machines can be hazardous in the hands of an unfamiliar, untrained or complacent operator. Do not risk injury or death!

- 5) Do not allow anyone to stand on the left side (discharge side) of the machine while it is in operation, whether it is moving or standing still.
- 6) Disengage PTO and shut off tractor engine before servicing, cleaning or clearing a clogged machine.
- 7) When the machine is in operation, keep in mind that soil, roots, rocks and other debris may be thrown 50 feet or more out the discharge side causing damage to an object or harm to a person within its range.
- 8) When using the optional deflector shield, use rubber straps to secure hoses on the tractor to keep them from getting into the PTO, otherwise damage may occur.
- 9) Be sure to keep the slip shaft portion (*See page 13 item L9*) of the PTO shaft well lubricated (*See Lubrication section on page 9*).
- 10) Do not engage PTO when tractor is running at high RPM. Slow RPM to idle before engaging PTO.
- 11) There are two (2) shear bolts in the PTO shaft (*See page 13 item L4*). If these bolts shear, stop the tractor, disengage the PTO, shut off tractor engine, and replace the sheared bolts.



WARNING! Shear bolts are designed to break under a specified load. Do not use a stronger bolt than is specified by manufacturer!

- 12) In normal conditions, when mud or trash becomes a problem, stop forward travel and allow the machine to clear itself before moving ahead. Note: The optional 6 paddle wheel should be used for extremely trashy conditions (*See page 14 item M1A*).
- 13) When using the optional deflector shield, adjust the height with the hydraulic cylinder in order to place the discharged soil where it is needed. NOTE: Remember the deflector shield extends three (3) feet beyond the left side of machine when attached. Use caution near fences, trees, or objects on the road.



- 14) **WARNING!** Do not operate this machine above 540 RPM if ditcher is rated for 540 RPM; above 1000 RPM if ditcher is rated for 1000 RPM. Excessive speed of PTO can be dangerous and could cause personal injury or damage to your tractor or ditcher.



- 15) **WARNING!** Do not exceed recommended horsepower (140 HP or less) for this machine. Excessive horsepower can be dangerous and could cause personal injury or damage to your tractor or ditcher.



- 16) **WARNING!** Do not use this machine with a PTO adaptor. The Agricultural Driveline Manufacturers Association and The Association of Equipment Manufacturers discourage the use of PTO adaptors due to serious safety and operational concerns.

MAINTENANCE

If you are not going to use your machine for a period of time, paint the areas where the soil has worn off the paint (for example: paddles). You should also apply a thin coat of grease to the exposed hydraulic cylinder rod of the optional deflector shield to prevent rusting and corrosion. Storing inside or covering with a tarp will extend the life of your ditcher.

After approximately every ten (10) hours of use, disconnect from tractor and check for the free movement of driveline and proper chain tension (*See Free Movement of Driveline section on page 9-10*).

When the impeller paddles are slightly worn, weld with a hard surfacing rod on each paddle to build them back up. Use a welding rod that is equal to a 60RC Rockwell hardness. NOTE: Be sure to

add the same amount of material to each paddle to keep the impeller assembly in balance. Replace paddles when worn flush with the impeller wheel.

If any component of your ditcher appears to be worn and needs replacement, please contact your dealer for replacement parts.

LUBRICATION

The Model 3-PT 15 has ten (10) grease fittings. Refer to the Parts Illustration on page 13 for the location of these fittings. Read carefully the information below on lubricating those areas.

NOTE: Damage may occur due to improper lubrication.

A – **DAILY** (every 8 hours) – Grease the following with gun grease:

- 1 – The slip joint between PTO halves (remove from tractor, separate halves, apply gun grease to all four sides of shaft, and reassemble).
- 2 – The two (2) universal joints at the ends of each PTO half. Slowly apply grease as to not overgrease and blow out seals.
- 3 – If using the optional deflector shield, check your tractor's hydraulic oil reservoir level. If system is empty (as when new), the ditcher's cylinder will require approximately 1/2 gallon of oil. Use a quality hydraulic oil of your choice.

B – **24 HOURS OF OPERATION**

- 1 – Check the enclosed gearbox oil level. Fill to the oil level check plug (about 4 inches above bottom) on back side of gearbox. The factory installed gearbox oil is Lucas ISO 680 industrial gear oil. Use of this oil is recommended as it is specifically formulated for peak performance of your Hurricane Ditcher.

C – **40–60 HOURS OR 1–2 WEEKS OF OPERATION** – Grease the following with gun grease:

- 1 – Four (4) flange ball bearings on gearbox – 1 pump each. Slowly apply grease as to not overgrease and blow out seals.
- 2 – One (1) pillow block bearing on drive shaft – 1 pump. Slowly apply grease as to not overgrease and blow out seals.
- 3 – Two (2) grease fittings on ratchet jack.

D – **100 HOURS OF OPERATION**

- 1 – Remove the inspection plate on the top of the gearbox; check for wear on bearings, sprockets, chain, and idler; and adjust the idler assembly as required (*See Idler Adjustment section on page 10*). Reinstall inspection plate using quality grade silicone sealant under the inspection plate.

FREE MOVEMENT OF DRIVELINE

When adjusted properly and operating correctly, the driveline should move freely by hand with no slack in the chain.



WARNING! Operation of improperly adjusted machine will cause damage to your ditcher and possibly to your tractor!



WARNING! Do not use your ditcher with a PTO adaptor. The Agricultural Driveline Manufacturers Association and The Association of Equipment Manufacturers discourage the use of PTO adaptors due to serious safety and operational concerns.

To check for free movement of driveline and proper tension on chain:

Step 1 – Grasp the front PTO yoke and quickly rock it back and forth. If the PTO moves before the impeller turns, the chain requires tightening (*See Idler Adjustment section on page 10*).

Step 2 – If the impeller is difficult to move, check for debris lodged in the machine. Remove any interfering debris and return to Step 1. If no interferences are found, continue to Step 3.

Step 3 – Check the pillow block bearing on the drive shaft. If damaged, repair as needed and return to Step 1. If no damage is found, continue to Step 4.

Step 4 – Remove the inspection plate on top of the gearbox and carefully inspect bearings, sprockets, chain, and idler for damage. If damage is found, repair as needed, reinstall inspection plate using quality grade silicone sealant under the inspection plate and return to Step 1. If no damage is found, continue to Step 5.

Step 5 – Release chain tension until impeller wheel and PTO turn freely (*See Idler Adjustment section below*).

IDLER ADJUSTMENT

Remove the inspection plate on top of the gearbox. Visually inspect the UHMW plastic wear pad for wear or damage (*See page 13 item D5*). Replace if needed. The idler adjustment assembly has one (1) bolt and one (1) nut (*See illustration below*). The bolt holds the idler assembly against the chain and the nut acts as a jam nut to lock the assembly in position. Reinstall inspection plate using quality grade silicone sealant under the inspection plate.

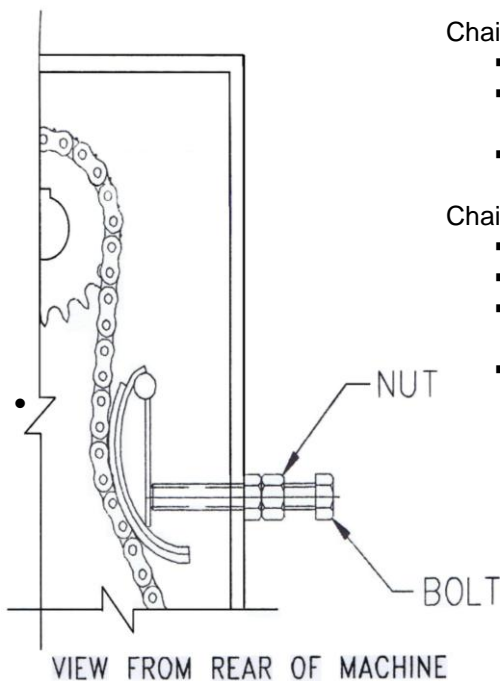

Chain needs **MORE** tension:

- Loosen Nut
- Tighten Bolt to remove any slack and apply slight tension on chain
- Tighten Nut to secure the assembly

Chain needs **LESS** tension:

- Loosen Nut
- Loosen Bolt until chain is too loose
- Tighten bolt to remove any slack and apply slight tension on chain
- Tighten Nut to secure the assembly

LIMITED WARRANTY

Hurricane Ditcher Company, Inc. shall be considered the "Company" throughout this warranty statement.

The Company warrants each new Company product to be free from defects in material and workmanship. This warranty is applicable only for the normal service life expectancy of the product or components, not to exceed twelve (12) consecutive months from the date of delivery of the new Company product to the end user for personal use. This warranty shall not exceed ninety (90) days from the date of delivery to the end user for commercial use.

Under no circumstances will it cover any merchandise or components thereof, which, in the opinion of the Company, has been subjected to misuse, unauthorized modifications, alterations, an accident, or if repairs have been made with parts other than those obtainable through the Company. The Company in no way warrants tires or other trade accessories since their respective manufacturers warrant these items separately. The Company's obligation under this warranty shall be limited to repairing or replacing free of charge to the original purchaser, any part that, in the Company's judgment, shall show evidence of such defect, provided further that such part shall be returned within thirty (30) days from the date of failure to the Company routed through the dealer and distributor from whom the purchase was made, transportation charges prepaid.

This warranty shall not be interpreted to render the Company liable for injury or damages of any kind or nature to person or property. This warranty does not extend to the loss of crops, loss because of delay in harvesting, or any expense or loss incurred for labor, substitute machinery, rental or for any other reason.

Except as set forth above, the Company shall have no obligation or liability of any kind on the account of any of its equipment and shall not be liable for special or consequential damages. The Company makes no other warranty, expressed or implied, and specifically, the Company disclaims any implied warranty or merchantability or fitness for a particular purpose. Some states or provinces do not permit limitations or exclusions of implied warranties or incidental or consequential damages, so the limitations or exclusions in this warranty may not apply in those areas.

This warranty is subject to any existing conditions of supply, which may directly affect our ability to obtain materials or manufacture replacement parts. The Company reserves the right to make improvements in design or changes in specifications at any time, without incurring any obligation to owners of units previously sold. No one is authorized to alter, modify, or enlarge this warranty. To enhance warranty, replace decals when worn, damaged or missing.

No warranty will be issued for bearing failure resulting from material wrapping around impeller shaft.

This warranty is not valid unless registered with Company within 30 days from the date of delivery to the end user.

HURRICANE DITCHER COMPANY, INC.
2425 Cathlinette Road
Vincennes, IN 47591
812-886-9663
www.hurricane-ditcher.com
info@hurricane-ditcher.com

ITEM	PART #	DESCRIPTION	QTY	ITEM	PART #	DESCRIPTION	QTY
A1	001571	PTO SHIELD	1	E5	001960	TOP LINK PIN CAT. 2	1
A2	000980	HEX HEAD CAP SCREW 1/4-20UNC X 1	2	E6	001220	ELEVATOR BUCKET BOLT 1/4-20UNC X 1	4
A3	001165	SPLIT LOCKWASHER 1/4	4	E7	001965	TOP LINK PIN CAT. 3	1
A4	001110	HEX NUT 1/4-20UNC	4	E8	001165	SPLIT LOCKWASHER 1/4	4
A5	000975	HEX HEAD CAP SCREW 1/4-20UNC X 3/4	2	E9	001110	HEX NUT 1/4-20UNC	4
B1	001285	HEX LOCK NUT 5/8-18UNF	4	F1	000105	FLANGE BALL BEARING 1-15/16	1
B8	003135	SHAFT WELDMENT 2-3/16 X 17-1/8 WITH 5/8 COLLAR	1	F3	001280	HEX LOCK NUT 1/2-20UNF	8
B9	002790	SQUARE KEY 1/2 X 2-7/8	1	F4	000120	FLANGE BALL BEARING 2-3/16	1
B10	001410	HEX HEAD CAP SCREW 5/8-18UNF X 2-1/4 GR. 8	4	F6	001285	HEX LOCK NUT 5/8-18UNF	8
C1	003580	IDLER ADJUSTING SCREW 3/4-10UNC X 5-1/2	1	F7	000125	FLANGE BALL BEARING WITH CAP 2-3/16	1
C2	001485	HEX NUT 3/4-10UNC	1	F7A	000220	BEARING CAP 2-3/16 (INCLUDED WITH F7)	1
C3	001370	HEX HEAD CAP SCREW 1/2-20UNF X 2 GR. 8	2	F8	000115	FLANGE BALL BEARING WITH CAP 1-15/16	1
C4	001470	FLAT WASHER 1/2	2	F8A	000215	BEARING CAP 1-15/16 (INCLUDED WITH F8)	1
C5	000876	BREATHER PLUG 1" (OIL FILL PLUG)	1	F9	000209	PILLOW BLOCK BEARING 1-3/4	1
C6	003491	INSPECTION PLATE (TOP)	1	G7	001435	HEX HEAD CAP SCREW 3/4-16UNF X 2 GR. 8	2
C7	001005	HEX HEAD CAP SCREW 3/8-16UNC X 1 GR. 5	14	G8	001290	HEX LOCK NUT 3/4-16UNF	2
C8	001170	SPLIT LOCKWASHER 3/8	14	L1	000680 / 000690	PTO SHAFT COMPLETE (INCLUDES ITEMS L4-L19) ****	1
C9	001458	HEX HEAD CAP SCREW 3/4-10UNC X 11 GR. 5	1	L2	000685 / 000695	PTO SHAFT FRONT HALF (INCLUDES ITEMS L4-L11) ****	1
C10	001280	HEX LOCK NUT 1/2-20UNF	2	L3	000700	PTO SHAFT REAR HALF (INCLUDES ITEMS L8,L11-L19)	1
C11	001234	NYLON HEX LOCK NUT 3/4-10UNC	1	L4	001005	SHEAR BOLT - HHCS 3/8-16UNC X 1 GR. 5 OR GR. 8	2
C13	000885	PIPE PLUG 3/4 NPT (OIL DRAIN PLUG)	1	L5	000725 / 000735	PTO SAFETY SLIDE LOCK ASSEMBLY ****	1
C14	000870	PIPE PLUG 1/4 NPT (OIL LEVEL CHECK PLUG)	1	L6	000740 / 000750	SHEAR YOKE ASSEMBLY ****	1
C15	003502	SIDE ACCESS DOOR (NOT SHOWN)	1	L7	001255	HEX LOCK NUT 3/8-16UNC	2
C16	001010	HHCS 3/8-16UNC X 1-1/4 GR. 5 (NOT SHOWN)	12	L8	001890	UNIVERSAL JOINT 1-3/4 55 SERIES	2
C17	001170	SPLIT LOCKWASHER 3/8 (NOT SHOWN)	12	L9	000820	YOKE AND SHAFT	1
D1	003111	SQUARE KEY 3/8 X 1-7/8	1	L10	000770	PTO OUTER GUARD (FRONT HALF)	1
D2	003115	UPPER SHAFT 1-15/16 X 27	1	L11	000715	RETAINER & NYLON KIT (NOT SHOWN)	2
D3	003112	SQUARE KEY 1/2 X 2-1/2	1	L13	000775	PTO INNER GUARD (REAR HALF)	1
D4	--	HHCS 3/8-16UNC X 1-1/4 (INCLUDED WITH D6)	3	L14	000785	YOKE, TUBE AND SLIP SLEEVE	1
D5	003659	IDLER UHM PLASTIC 5 X 8	1	L15	000815	YOKE 1-3/4 KEYPED	1
D6	000380	SPLIT TAPER BUSHING 1-15/16	1	L16	001320	HEX HEAD CAP SCREW 3/8-16UNC X 3-1/2 GR. 8	1
D7	--	RECTANGULAR KEY 1/2 X 3/4 (INCLUDED WITH D6)	1	L17	001255	HEX LOCK NUT 3/8-16UNC	1
D8	000300	18 TOOTH D80 SPROCKET	1	L18	002811	SET SCREW 3/8-16 X 3/8	1
D9	003690	IDLER ASSEMBLY	1	L19	002812	SET SCREW 3/8-16 X 1/4	1
D10	--	HHCS 3/8-16UNC X 1-3/4 (INCLUDED WITH D12)	3	M1	003385	5-PADDLE IMPELLER WHEEL	1
D11	000485	CONNECTING LINK D80	1	M2	001265	HEX LOCK NUT 1/2-13UNC	15
D12	000395	SPLIT TAPER BUSHING 2-3/16	1	M3	003300	HARD SURFACED BOLT-ON PADDLE	5
D13	--	RECTANGULAR KEY 1/2 X 3/4 (INCLUDED WITH D12)	1	M4	000925	FLAT HEAD PLOW BOLT 1/2-13UNC X 1-1/2 GR. 8	15
D14	000325	30 TOOTH D80 SPROCKET	1	M8	003510	DRAG PLATE	1
D15	000555	DOUBLE STRAND ROLLER CHAIN D80 (72 PITCH)	1	M9	001840	RATCHET JACK (INCLUDES HANDLE AND COTTER PIN)	1
D16	003535	SPACER 1-15/16 ID X 4-3/8 LONG	1	M10	001839	CLEVIS PIN (INCLUDED WITH M9)	2
D17	003540	SPACER 1-15/16 ID X 3-1/2 LONG	1	M11	001838	PIN CLIP (INCLUDED WITH M9)	4
D18	003542	SPACER 2-3/16 ID X 4-3/8 LONG	1	P1	003650	PARKING STAND (2-PIECE SET)	2
E1	003715	HITCH PIN 1-1/8 X 10	2	P2	001975	PARKING STAND LOCK PIN	4
E2	001966	LYNCH PIN	4	O1	002272	LUCAS ISO 680 INDUSTRIAL GEAR OIL (1-1/2 GALLON)	1
E3	003712	HITCH SPACER 1-1/4 ID X 1	8			****SPECIFY 1-3/8-21 SPL OR 1-3/4-20 SPL****	
E4	001865	LIFT ARM BUSHING 1-1/8 ID X 2-3/4 LONG	2				

UPDATED DECEMBER 2010

3-PT 15

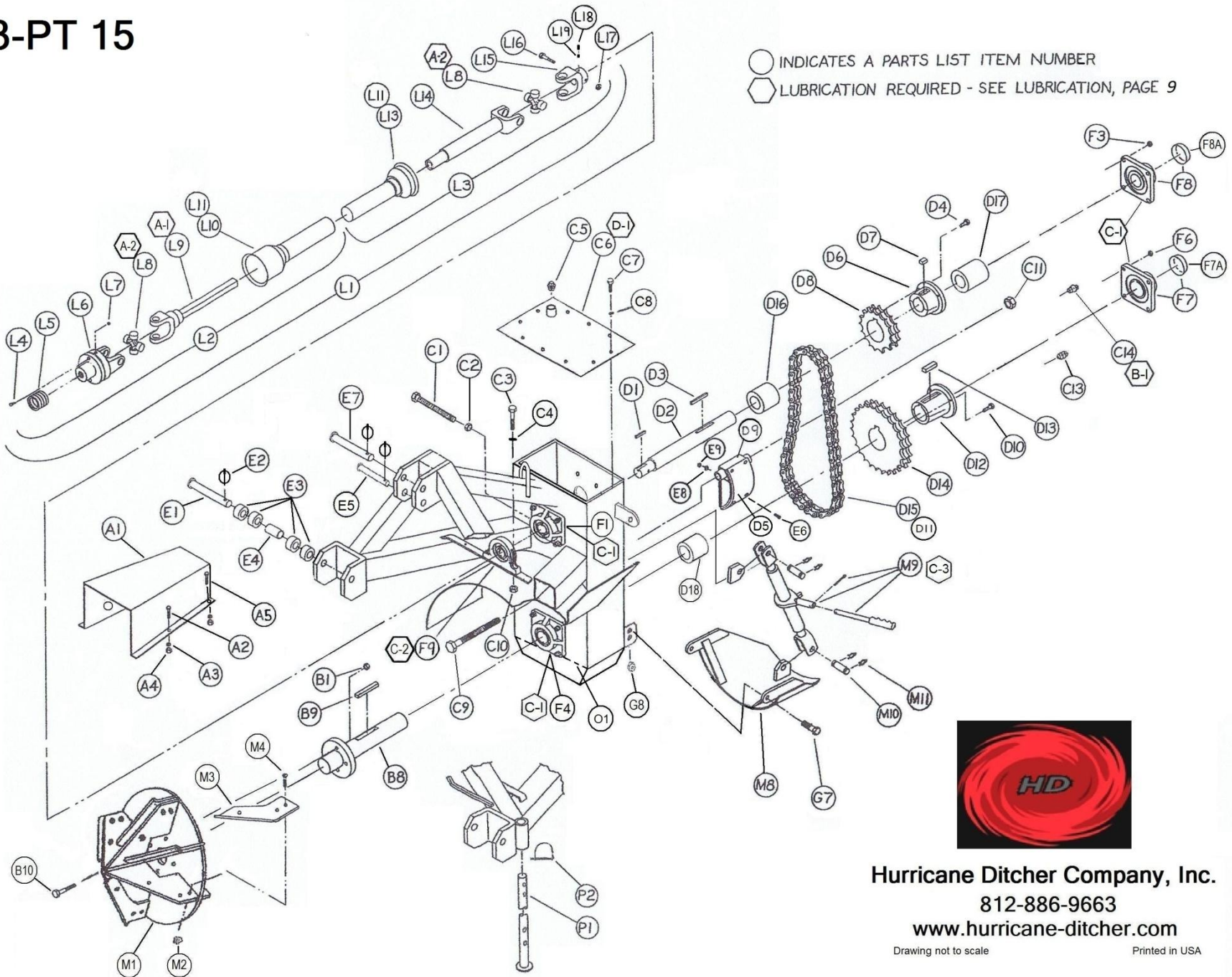

Hurricane Ditcher Company, Inc.

812-886-9663

www.hurricane-ditcher.com

Drawing not to scale

Printed in USA

ITEM	PART #	DESCRIPTION	QTY
		DEFLECTOR SHIELD ASSEMBLY	
N1	003680	DEFLECTOR SHIELD	1
N2	003495	CYLINDER MOUNTING BRACKET	1
N3	003496	CYLINDER MOUNTING BRACKET RETAINER	1
N4	001175	SPLIT LOCK WASHER 1/2	6
N5	001125	HEX NUT 1/2-13UNC	6
N6	001055	HEX HEAD CAP SCREW 1/2-13UNC X 6 GR. 5	2
N7	003505	DEFLECTOR SHIELD BRACKET (FRONT)	1
N8	003506	DEFLECTOR SHIELD BRACKET RETAINER	1
N9	001285	HEX LOCK NUT 5/8-18UNF	2
N10	002133	CLIP PIN (INCLUDED WITH N12)	2
N11	002132	CYLINDER PIN (INCLUDED WITH N12)	2
N12	002100	HYDRAULIC CYLINDER 2 X 8 STROKE	1
N13	002049	HYDRAULIC HOSE 1/2 X 5' 2 WIRE WITH 1/2 NPT MALE END	2
N14	001906	1/2 NPT ISO TIP	2
N15	001825	3/8 45 DEGREE SWIVEL ADAPTER	2
N16	001410	HEX HEAD CAPSCREW 5/8-18UNF X 2-1/4 GR. 8	2
N17	001050	HEX HEAD CAP SCREW 1/2-13UNC X 5 GR. 5	4
N18	001470	FLAT WASHER 1/2	12

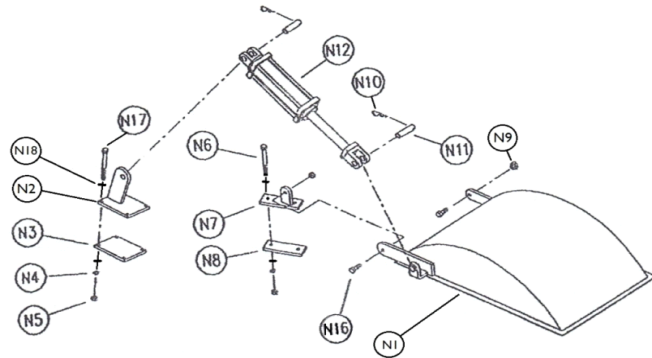

ITEM	PART #	DESCRIPTION	QTY
		540 RPM OPTION	
D6	000390	SPLIT TAPER BUSHING 1-15/16	1
D8	000325	30 TOOTH D80 SPROCKET	1
D9	003691	IDLER ASSEMBLY	1
D15	000557	DOUBLE STRAND ROLLER CHAIN D80 (78 PITCH)	1
E6	001220	ELEVATOR BUCKET BOLT 1/4-20UNC X 1	4
E8	001165	SPLIT LOCKWASHER 1/4	4
E9	001110	HEX NUT 1/4-20UNC	4
L4	001005	SHEAR BOLT - HHCS 3/8-16UNC X 1 GR. 5 OR GR. 8	1
L5	000735	PTO SAFETY SLIDE LOCK ASSEMBLY	1
L6	000745	SHEAR YOKE ASSEMBLY	1
L7	001255	HEX LOCK NUT 3/8-16UNC	1

ITEM	PART #	DESCRIPTION	QTY
		RIPPER TOOTH ASSEMBLY	
T1	003620	BIT	1
T2	001034	HEX BOLT 1/2-13UNC X 2-1/4 GR. 5	1
T3	001265	HEX LOCK NUT 1/2-13UNC	1
T4	003615	TOOTH SUPPORT BRACKET	1
T5	003616	TOOTH RETAINER BRACKET	1
T6	003617	SUPPORT BRACKET RETAINER	2
T7	001075	HEX HEAD CAP SCREW 3/4-10UNC X 3 GR. 5	4
T8	001131	HEX NUT 3/4-10UNC	12
T9	001086	HEX HEAD CAP SCREW 3/4-10UNC X 6-1/2 GR. 5	8
T11	001520	SPLIT LOCK WASHER 3/4	12
T12	003625	TOOTH	1

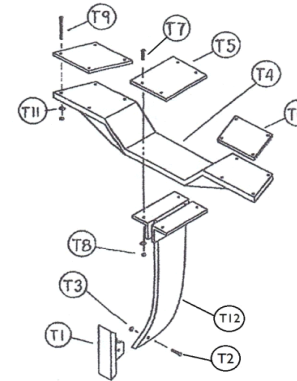

ITEM	PART #	DESCRIPTION	QTY
		6-PADDLE IMPELLER WHEEL ASSEMBLY	
M1A	003395	6-PADDLE IMPELLER WHEEL	1
M2A	001265	HEX LOCK NUT 1/2-13UNC	18
M3A	003305	HARD SURFACE BOLT-ON PADDLE	6
M4A	000925	FLAT HEAD PLOW BOLT 1/2-13UNC X 1-1/2 GR. 8	18

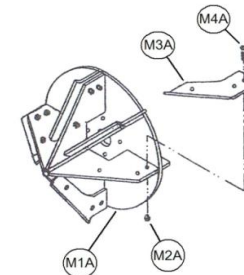

THE HURRICANE

3-PT 15 DITCHER



HURRICANE DITCHER CO., INC.

2425 Cathlinette Rd.
Vincennes, IN 47591

812-886-9663 Fax 812-886-0530

www.hurricane-ditcher.com

e-mail: info@hurricane-ditcher.com

